

Packaged Terminal Air Conditioner (PTAC) FFRP072LT6

Air Conditioner/
Electric Heater

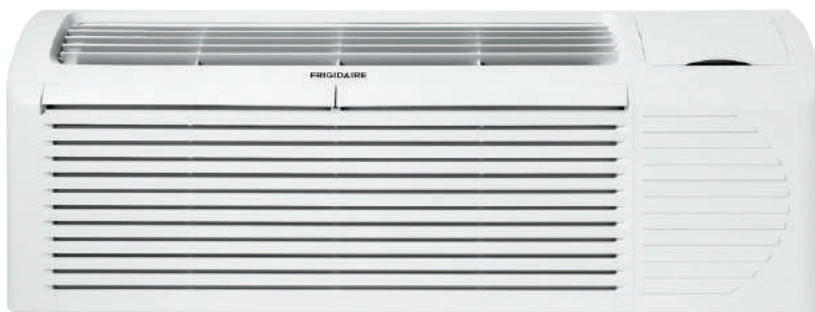

Product Dimensions

Height	16"
Width	42"
Depth	21-3/4"

More Easy-To-Use Features

Comfort Control Design

Simple controls allow guests to customize their settings, while quiet, uniform air movement keeps rooms comfortable.

Smart Self-Check

Provides nine diagnostic points for self-check and correction of fault conditions.

Eco-Friendly

Frigidaire® uses R-410A refrigerant that's not harmful to the earth's ozone layer and meets U.S. Environmental Protection Agency requirements.

Effortless™ Operation

Simple, intuitive room controls are easy for guests to operate — ensuring a relaxing, more comfortable stay. Features like Effortless™ Restart and Ready-Select® controls reduce maintenance calls.

Performance	BTUs
Cool	7,200
Electric Heater	11,700



Signature Features

Corrosion Guard

A corrosion-resistant fin coating extends operation life and your investment, plus it is easier to maintain in coastal environments.

Dry Mode

Dry Mode feature will help manage and reduce the humidity content within the living space, making it more comfortable.

Effortless™ Maintenance

With Frigidaire's reputation for durability, easy maintenance, availability of reliable parts and service you can count on, you can be sure that you're getting the highest-quality performance.

SilentDesign™

Sound reduction package.

Performance	
BTU (Cool)	7,200
BTU (Electric Heater)	11,700
Dehumidification (Pints/Hour)	1.7
Cool Area (Sq. Ft.)	300
Energy Efficiency Ratio	13.0
Electrical	
Volts	265
Amps (Cool)	2.4
Amps (Electric Heater)	13.1
Watts (Cool)	550
Watts (Electric Heater)	3,450
Cable Included	Yes
Length of Power Cord	2.3'
Circuit Breaker	20A
Plug Type (NEMA)	LCDI (7-20P)
Features	
Fin Coating	Corrosion Guard
Dry Mode	Yes
Electronic Controls	Ready-Select® Controls
Front Desk Control Ready	Yes
Fan Speeds (Dry / Cool / Fan / Heat)	1 / 2 / 2 / 2
Noise Level Indoors (High / Low)	50 / 48
Quiet Start-Up	Yes
Low Voltage Start-Up	Yes
Random Restart Protection	Yes
Effortless™ Auto Freeze Protection	Yes
Energy Save	Yes
24-Hour On / Off Timer	Yes
Air CFM (High / Low)	312 / 282
Air Direction Control	Auxiliary 2-Way
Air Intake	Fresh or Recycled
Filter Type	Nylon Mesh
Filter Access	Slide-Out
Slide-Out Chassis	Yes
Commercial Grade Warranty ¹	Yes
Certifications	
Safety Certification	UL, CUL & CSA
Performance	AHRI & CEC
Specifications	
Refrigerant	R410a
Charge	22.9 oz.
Shipping Weight (Approx.)	128 Lbs.

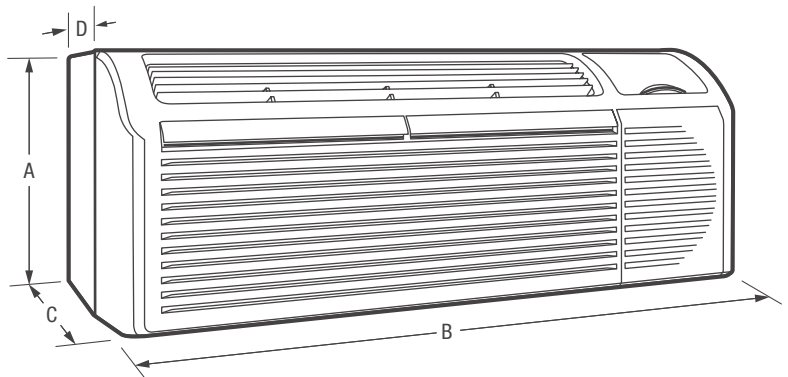
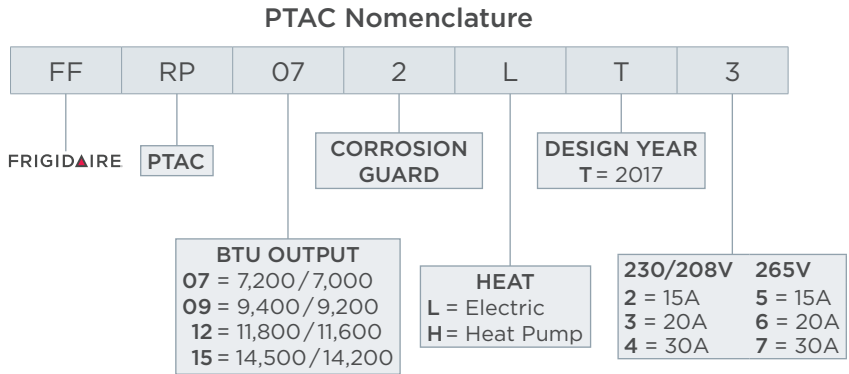

¹Warranty 5 year sealed system / 2 year full parts and labor.



Plug Type (NEMA)
7-20P

NOTE: For planning purposes only. Always consult local and national electric codes. Refer to Product Installation Guide for detailed installation instructions on the web at frigidaire.com.



Product Dimensions	
A - Height	16"
B - Width	42"
C - Depth (Overall Unit)	21-3/4"
D - Depth (Inside Sleeve)	13-3/4"
Max. Wall Thickness	13-1/2" ²

Wall Cutout Dimensions	
Height	16-1/4"
Width	42-1/4"

²Unless the PTAC unit is installed with a wall sleeve.

Accessories information available on the web at frigidaire.com

FRIGIDAIRE

USA • 10200 David Taylor Drive • Charlotte, NC 28262 • 1-800-FRIGIDAIRE • frigidaire.com
CANADA • 5855 Terry Fox Way • Mississauga, ON L5V 3E4 • 1-800-265-8352 • frigidaire.ca

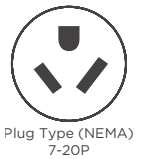
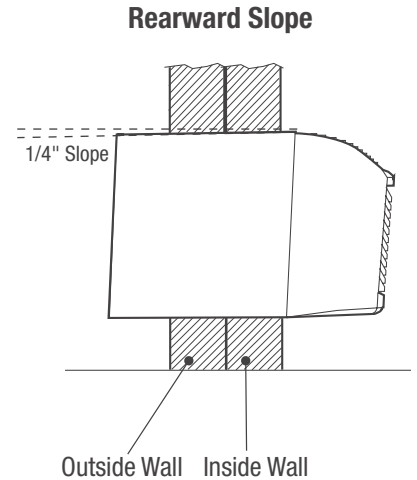
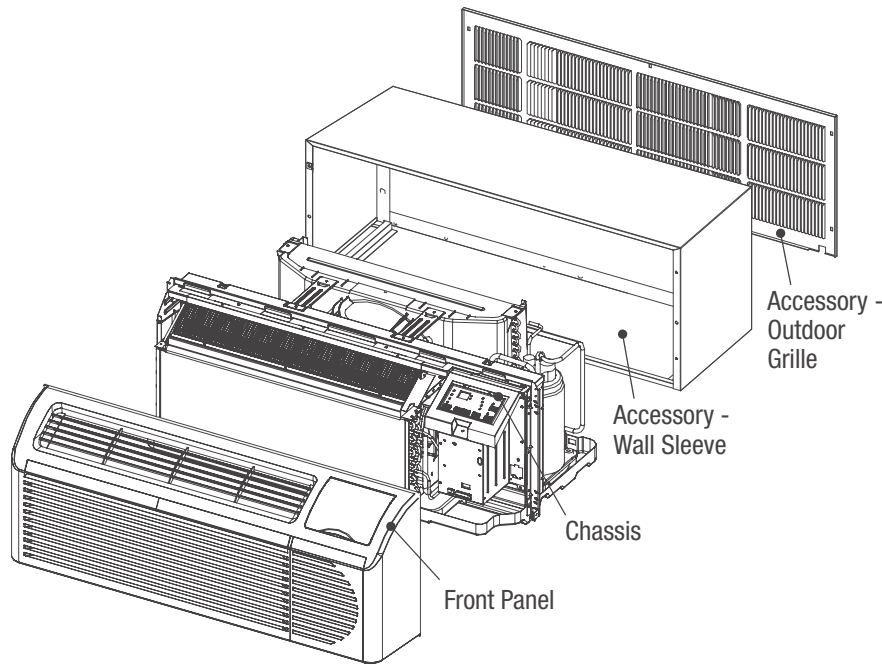

Product Dimensions	
Height	16"
Width	42"
Depth (Overall Unit)	21-3/4"
Depth (Inside Sleeve)	13-3/4"
Max. Wall Thickness	13-1/2"

Wall Cutout Dimensions	
Height	16-1/4"
Width	42-1/4"

PTAC Specifications

- Product Shipping Weight (approx.) - 128 Lbs.
- An electrical supply with grounded three-prong receptacle is required. The power supply circuit must be installed in accordance with current edition of National Electrical Code (ANSI/NFPA 70) and local codes & ordinances.
- Voltage Rating - 265V/60 Hz
- Amps @ 265V Volts = (Cool) 2.4 Amps/(Electric Heater) 13.1 Amps
- Always consult local and national electric codes.
- Recommended Circuit Breaker - 20 Amps
- Unit equipped with 265V 3-wire power supply cord, NEMA plug type 7-20P, approximately 28" long.
- In order for condensate water to drain properly inside the unit, the sleeve must be installed properly: Level from right to left with a slight 1/4" rearward pitch from the indoor side to the outdoor side as shown in the illustration above. Refer to the Installation Instructions on the web.
- The drain kit listed on the Frigidaire® PTAC Accessories page can be used for an internal or external drain. This applies to new and replacement installation.

New Installation

- For new installation, Frigidaire® PTAC Sleeves are available and recommended for proper installation. See accessories pages for sleeve options.*
- Standard PTAC installation requires 13-1/2" maximum wall thickness, unless a wall sleeve is used.
- If the PTAC unit protrudes more than 4", then it is suggested that it be installed with a subbase. See accessories pages for subbase options.

Replacement Installation

- When replacing existing PTAC with new unit, refer to Product Installation Guide on web to identify existing wall-sleeve manufacturer and size compatibility. If proper installation and slope are suspect, then correct installation of Frigidaire® PTAC Sleeve options recommended.
- For any sleeve retrofit application, be sure that the foam seals (factory-installed on the tube sheets) provide a good seal between the grille and the outdoor coil tube sheets. These foam seals provide a barrier that stops air from the inside mixing with air on the outside (known as air recirculation).
- Using Frigidaire® wall sleeve with Non-Frigidaire grille requires installation of an Accessory Baffle Kit, which ensures a good seal between the unit and exterior grille to prevent air recirculation. Air recirculation is a large contributor to performance loss and premature damage to major components.

Note: For planning purposes only. Refer to Product Installation Guide on the web at frigidaire.com for detailed instructions.

*See Frigidaire® PTAC accessories pages attached for optional accessories.

FRIGIDAIRE

USA • 10200 David Taylor Drive • Charlotte, NC 28262 • 1-800-FRIGIDAIRE • frigidaire.com
 CANADA • 5855 Terry Fox Way • Mississauga, ON L5V 3E4 • 1-800-265-8352 • frigidaire.ca



Packaged Terminal Air Conditioner (PTAC)

ACCESSORIES

FRIGIDAIRE®

Metal Wall Sleeve



Polymer Wall Sleeve



Condensation Universal Drain Kit

Stamped Aluminum Grille



Architectural Aluminum Grille

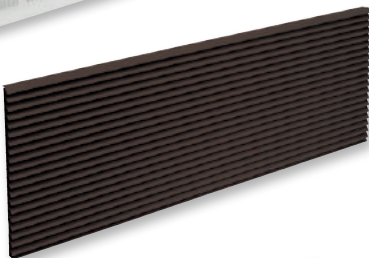

Polymer Architectural Grille



Wall Sleeves and Drain Kit

Metal Wall Sleeve & Accessories

- 5304482701** Steel Sleeve - Insulated
- 5304483759** 16" Extended Sleeve - Insulated
- 5308815304** 18" Extended Sleeve - Insulated
- 5308815305** 24" Extended Sleeve - Insulated
- 5304483760** 3" Sleeve Adapter

These fully insulated sleeves are made of electro-galvanized steel that resists corrosion, and welded areas are sealed with a rust preventive. White powder coating matches PTAC units. Sliding keyhole grille attachments enable easy, one-person installation from the inside.

Polymer Wall Sleeve

- 5308815302** Insulated

Utilizes fiberglass-reinforced polyester compound to produce a durable, noncorrosive wall case that provides superior sound absorption, reduces heat loss and prevents sleeve sweating. (Requires use of a Polymer Architectural Grille.)

Condensation Universal Drain Kit

- 5304480570** 1-Pack

Controls condensate from the PTAC unit and can be used for exterior or interior drain systems. Includes 1/2" O.D. copper drain tubes with a short right angle tube and a 6" straight tube to suit the application. (Recommended for all new sleeve installations.)

Outdoor Grilles

Stamped Aluminum Outdoor Grille

- 5304480557** Clear Anodized Aluminum Finish

Cost-effective, one-piece stamped grille is made from durable anodized aluminum. The grille is lightweight, has a clear finish and is easy to install from inside the room.

Architectural Aluminum Outdoor Grilles

- 5304480558** Clear Anodized Aluminum Finish
- 5308815313** Dark Brown
- 530448055X** Customized Color

Enhances the appearance of any building. Made of a durable, anodized aluminum that offers weather resistance. Sliding keyhole attachment enables easy installation onto Frigidaire® metal wall sleeve.

Polymer Architectural Outdoor Grilles

- 5308815310** Brown
- 5308815312** Alpine Beige

Blends with most building exteriors. Its durable design offers protection, has an enhanced appearance and provides superior weather resistance. (Requires use of a Polymer Wall Sleeve.)

Packaged Terminal Air Conditioner (PTAC)

ACCESSORIES

FRIGIDAIRE

Decorative Subbase

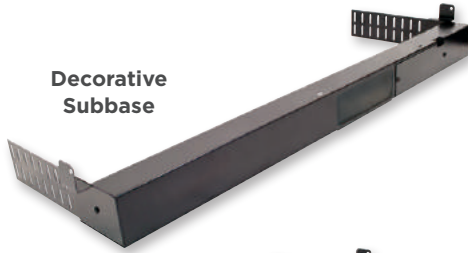

Electrical Subbase



Leveling Legs



Air Filters



Wall Thermostats



FFTSTATWL



5304483050

Lateral Duct Kit



Subbases and Leveling Legs

Decorative Subbase

5308815315 Black

Made of heavy-gauge steel to provide support for the wall sleeve, the subbase mounts directly to the wall sleeve and has adjustable leveling legs.

Black Electrical Subbases

5304482886 230V/15A

5304482891 265V/30A

5304482888 230V/30A

5304482890 265V/20A

5304482887 230V/20A

5304482698

265V Subbase Disconnect Switch

5304490211

Hardwire Kit, Conduit and Plate

(For 230V and 265V)

Offers the same features as the decorative subbase, plus a factory-installed electrical junction box containing a receptacle for corded PTAC units.

Leveling Legs

5304480575

Attach easily to the wall sleeve and offer accurate leveling and support for units without a subbase. Adjustable from 3-1/4" to 5-1/2".

Air Filters

Air Filters

5304482892 10-Pack

Changing filters periodically ensures a healthy room environment, proper airflow, temperature control and energy efficiency.

Wall Thermostats

Wireless Digital Wall Thermostat

FFTSTATWL Non-Programmable (Includes Wireless Receiver)

Allows control without having to worry about wiring. Easy to install and use. Large intuitive LCD screen improves user interaction.

Wired Digital Wall Thermostats

5304482700 Programmable

5304483050 Non-Programmable

Offers auto-changeover, 2-stage heating and cooling, as well as emergency heating mode for heat pump.

Laminated Insert

FPTAC0511

Informs guests that unit is controlled by wall thermostat.

Miscellaneous

Lateral Duct Kit

5304490206

Allows one PTAC unit to heat or cool two rooms. Kit mounts to wall sleeve and can be installed for either right- or left-side duct applications.

Baffle Kit

5304484585

Baffle Kit for use on non-standard grilles.